



N-Channel Depletion-Mode MOSFET

Ordering Information

BV _{DSX} / BV _{DGX}	R _{DS(ON)} (max)	I _{DSS} (min)	Order Number / Package		
			TO-92	TO-243AA*	Die
500V	1.0KΩ	1.0mA	LND150N3	LND150N8	LND150ND

* Same as SOT-89. Product shipped on 2000 piece carrier tape reels.

Product marking for TO-243AA:

LN1E*

Where * = 2-week alpha date code

Features

- ESD gate protection
- Free from secondary breakdown
- Low power drive requirement
- Ease of paralleling
- Excellent thermal stability
- Integral source-drain diode
- High input impedance and low C_{ISS}

Applications

- Solid state relays
- Normally-on switches
- Converters
- Power supply circuits
- Constant current sources
- Input protection circuits

Absolute Maximum Ratings

Drain-to-Source Voltage	BV _{DSX}
Drain-to-Gate Voltage	BV _{DGX}
Gate-to-Source Voltage	±20V
Operating and Storage Temperature	-55°C to +150°C
Soldering Temperature*	300°C

* Distance of 1.6 mm from case for 10 seconds.

Advanced DMOS Technology

The LND1 is a high voltage N-channel depletion mode (normally-on) transistor utilizing Supertex's lateral DMOS technology. The gate is ESD protected.

The LND1 is ideal for high voltage applications in the areas of normally-on switches, precision constant current sources, voltage ramp generation and amplification.

Package Options

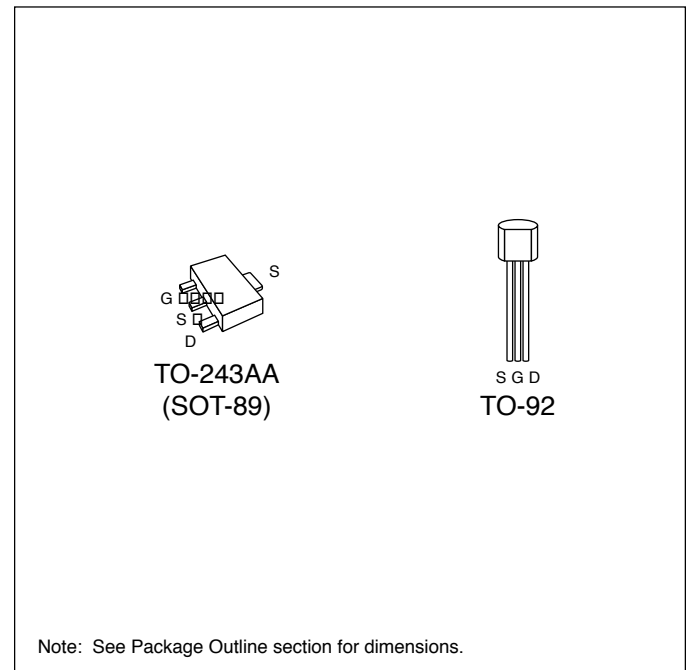

Thermal Characteristics

Package	I_D (continuous)*	I_D (pulsed)	Power Dissipation @ $T_A = 25^\circ\text{C}$	θ_{jc} $^\circ\text{C/W}$	θ_{ja} $^\circ\text{C/W}$	I_{DR}	I_{DRM}^*
TO-92	30mA	30mA	0.74W	125	170	30mA	30mA
TO-243AA	30mA	30mA	1.6W†	31	105†	30mA	30mA

* I_D (continuous) is limited by max rated T_r .

† Mounted on FR5 Board, 25mm x 25mm x 1.57mm. Significant P_D increase possible on ceramic substrate.

Electrical Characteristics (@ 25°C unless otherwise specified)

Symbol	Parameter	Min	Typ	Max	Unit	Conditions
BV_{DSX}	Drain-to-Source Breakdown Voltage	500			V	$V_{GS} = -10\text{V}$, $I_D = 1.0\text{mA}$
$V_{GS(OFF)}$	Gate-to-Source OFF Voltage	-1.0		-3.0	V	$V_{DS} = 25\text{V}$, $I_D = 100\text{nA}$
$\Delta V_{GS(OFF)}$	Change in $V_{GS(OFF)}$ with Temperature			5.0	mV/ $^\circ\text{C}$	$V_{DS} = 25\text{V}$, $I_D = 100\text{nA}$
I_{GSS}	Gate Body Leakage Current			100	nA	$V_{GS} = \pm 20\text{V}$, $V_{DS} = 0\text{V}$
$I_{D(OFF)}$	Drain-to-Source Leakage Current			100	nA	$V_{GS} = -10\text{V}$, $V_{DS} = 450\text{V}$
				100	μA	$V_{GS} = -10\text{V}$, $V_{DS} = 0.8\text{V}$ max rating $T_A = 125^\circ\text{C}$
I_{DSS}	Saturated Drain-to-Source Current	1.0		3.0	mA	$V_{GS} = 0\text{V}$, $V_{DS} = 25\text{V}$
$R_{DS(ON)}$	Static Drain-to-Source ON-State Resistance		850	1000	Ω	$V_{GS} = 0\text{V}$, $I_D = 0.5\text{mA}$
$\Delta R_{DS(ON)}$	Change in $R_{DS(ON)}$ with Temperature			1.2	%/ $^\circ\text{C}$	$V_{GS} = 0\text{V}$, $I_D = 0.5\text{mA}$
G_{FS}	Forward Transconductance	1.0	2.0		m \bar{S}	$V_{GS} = 0\text{V}$, $I_D = 1.0\text{mA}$
C_{ISS}	Input Capacitance		7.5	10	pF	$V_{GS} = -10\text{V}$, $V_{DS} = 25\text{V}$ $f = 1\text{MHz}$
C_{OSS}	Output Capacitance		2.0	3.5		
C_{RSS}	Reverse Transfer Capacitance		0.5	1.0		
$t_{d(ON)}$	Turn-ON Delay Time		0.09		μs	$V_{DD} = 25\text{V}$, $I_D = 1.0\text{mA}$, $R_{GEN} = 25\Omega$
t_r	Rise Time		0.45			
$t_{d(OFF)}$	Turn-OFF Delay Time		0.1			
t_f	Fall Time		1.3			
V_{SD}	Diode Forward Voltage Drop			0.9	V	$V_{GS} = -10\text{V}$, $I_{SD} = 1.0\text{mA}$
t_{rr}	Reverse Recovery Time		200		ns	$V_{GS} = -10\text{V}$, $I_{SD} = 1.0\text{mA}$

Notes:

- All D.C. parameters 100% tested at 25°C unless otherwise stated. (Pulse test: 300 μs pulse, 2% duty cycle.)
- All A.C. parameters sample tested.

Switching Waveforms and Test Circuit

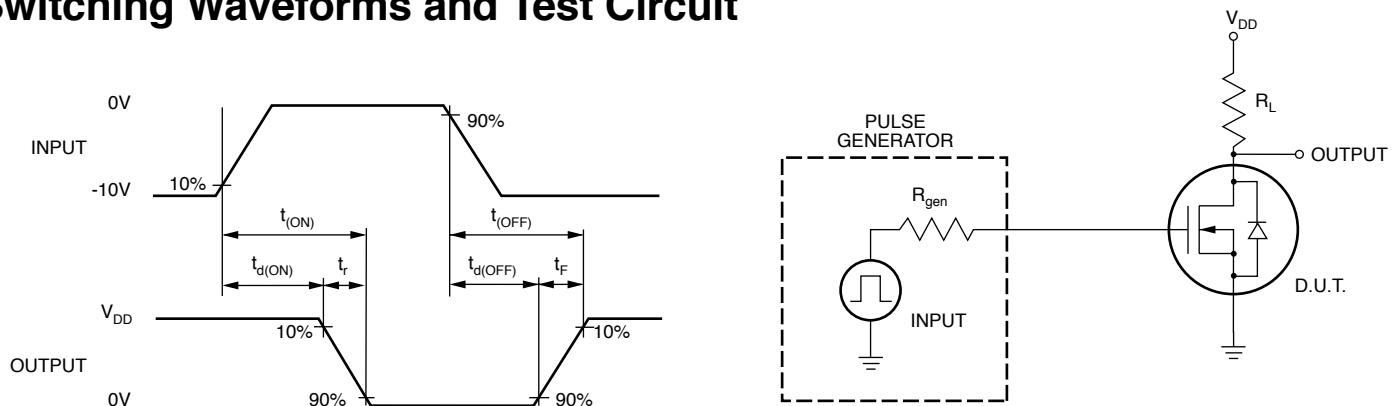

Typical Performance Curves

Output Characteristics

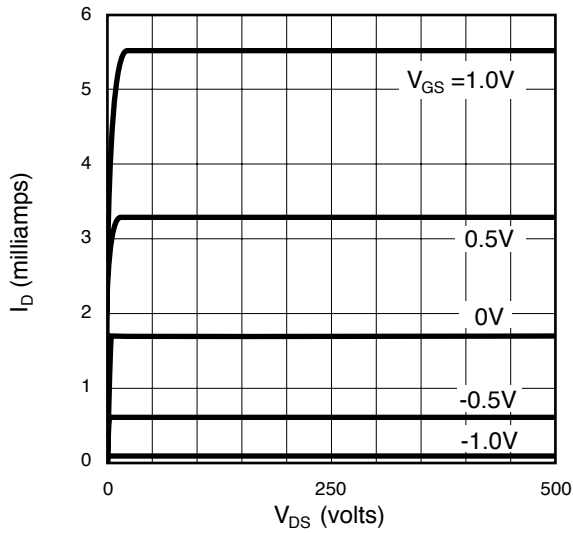

Saturation Characteristics

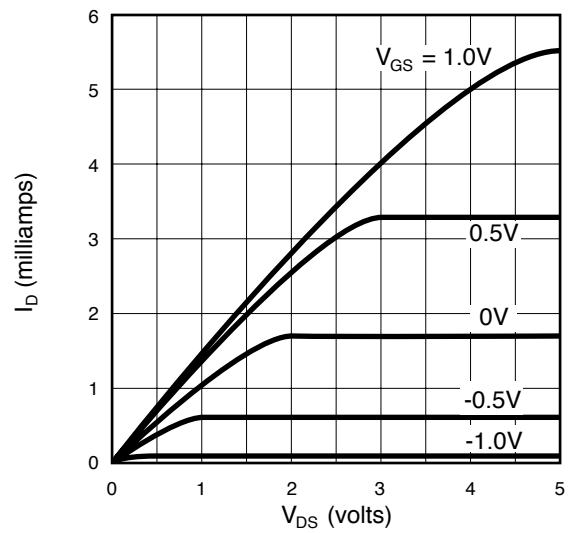

Transconductance vs. Drain Current

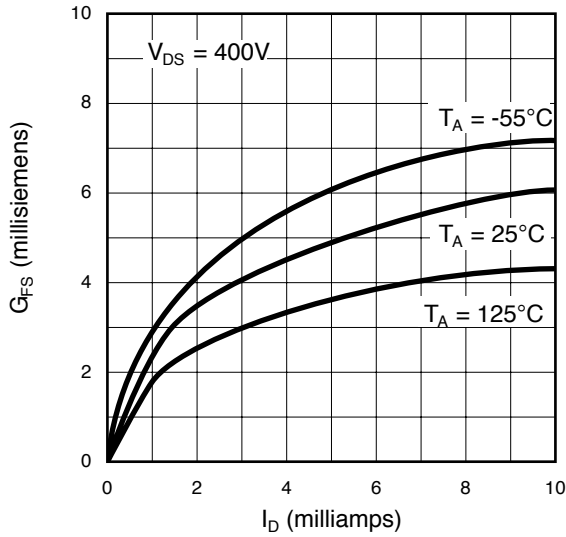

Power Dissipation vs. Ambient Temperature

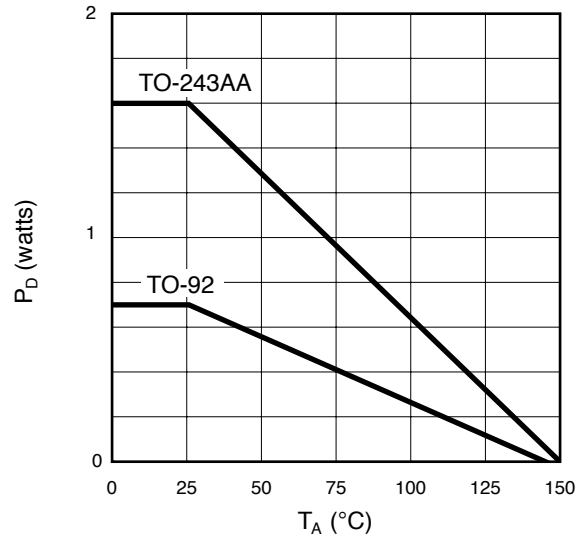

Maximum Rated Safe Operating Area

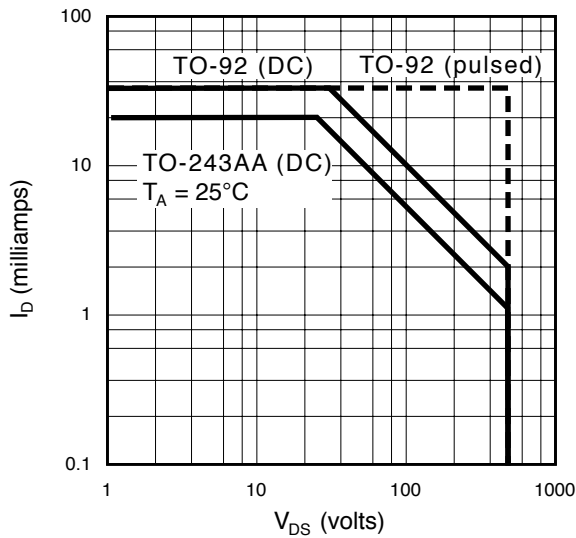

Thermal Response Characteristics

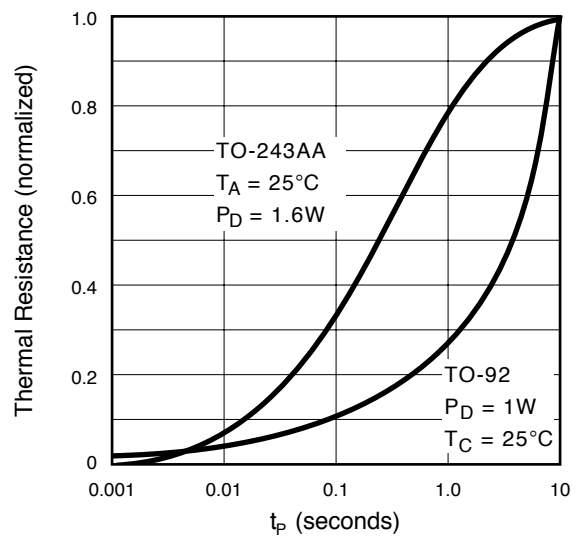

Typical Performance Curves

BV_{DSS} Variation with Temperature

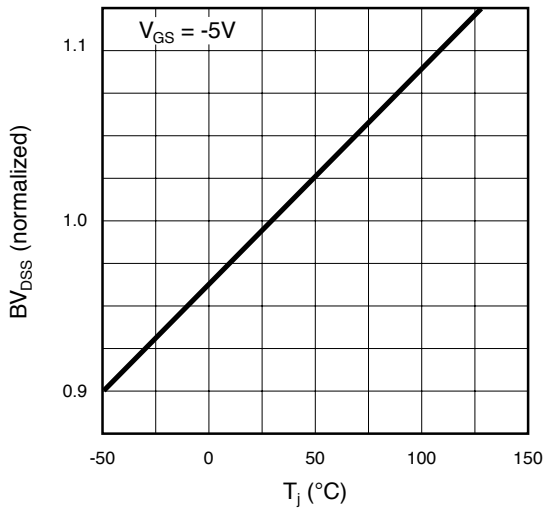

I_D vs. R_{SOURCE}

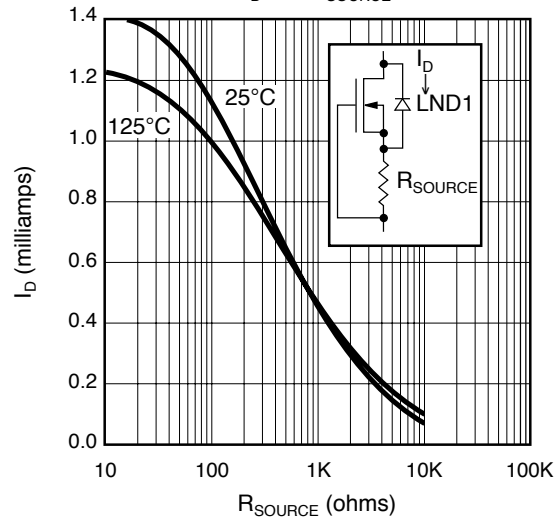

Transfer Characteristics

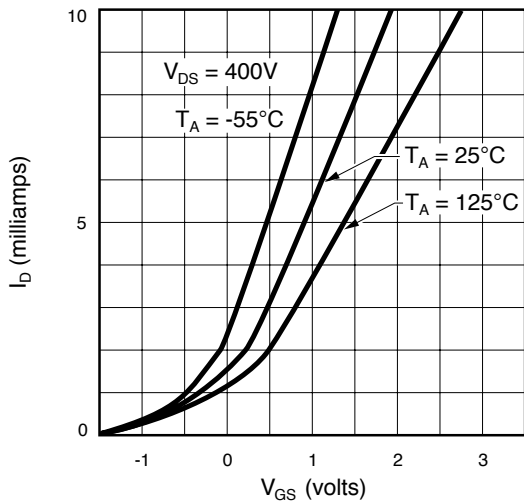

V_{GS(OFF)} and R_{DS} Variation with Temperature

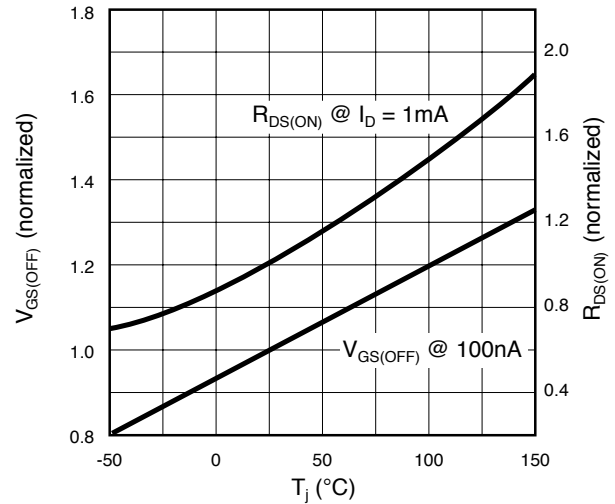

Capacitance vs. Drain-to-Source Voltage

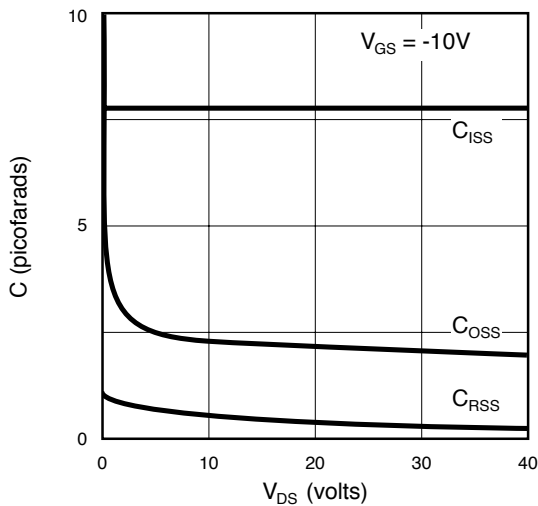

Gate Drive Dynamic Characteristics

